

**BERKELEY NUCLEONICS CORPORATION**  
**PVX-4150 PULSE GENERATOR**  
**OPERATION MANUAL**

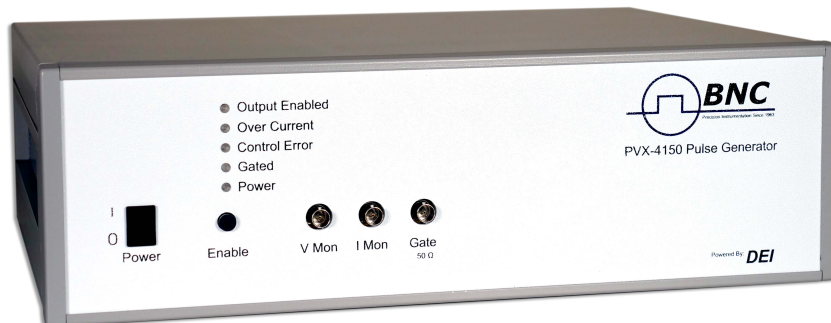

Berkeley Nucleonics Corp.  
San Rafael USA  
415-453-9955

**TABLE OF CONTENTS**

1.0 GENERAL DESCRIPTION .....4  
2.0 SPECIFICATIONS .....5  
3.0 SAFETY .....6  
    3.1 Operating Safety Summary .....6  
        3.1.1 Power Source .....6  
        3.1.2 Grounding.....7  
        3.1.3 Cover Removal.....7  
        3.1.4 General Operating Precautions .....7  
    3.2 Servicing Safety Summary .....7  
        3.2.1 Servicing Procedure .....7  
        3.2.2 Internal Energy Storage.....7  
4.0 OPERATING CONSIDERATIONS.....9  
    4.1 Output Cabling .....9  
    4.2 Load Simulation .....9  
    4.3 Trigger Input.....9  
    4.4 Pulse Voltages +V IN and -V IN .....9  
    4.5 Output Pulse Considerations.....9  
    4.6 Controls and Indicators .....10  
        4.6.1 Power Switch and LED.....10  
        4.6.2 Enable Switch and LED.....10  
        4.6.3 Gate Connector .....11  
        4.6.4 Gated LED.....11  
        4.6.5 Over Current LED.....11  
        4.6.6 Control Error LED.....11  
        4.6.7 Current Monitor.....11  
        4.6.8 Voltage Monitor .....11  
    4.7 Remote Control.....12  
5.0 PREPARATION FOR USE .....14  
    5.1 General .....14  
    5.2 Initial Inspection .....14  
    5.3 Electrical Installation.....14  
        5.3.1 Input Power Cord.....14  
    5.4 Electrical Check .....14  
        5.4.1 Power-Up .....14  
6.0 OPERATING INSTRUCTIONS .....16  
    6.1 Power-Up Procedures .....16  
    6.2 Power-Down Procedures .....16  
7.0 TROUBLESHOOTING .....17  
    7.1 Troubleshooting Procedures .....17  
        7.1.1 Fuses.....18  
    7.2 Factory Service .....18  
8.0 SYSTEM FAILURE MODES .....19

8.1 Over-Current Failure .....	19
9.0 WARRANTY .....	19
APPENDIX.....	21
Typical Output Waveforms .....	21

\*\*\*\*\* **WARNING** \*\*\*\*\*

SAFE OPERATING PROCEDURES AND PROPER USE OF THE EQUIPMENT ARE THE RESPONSIBILITY OF THE USER OF THIS SYSTEM.

Berkeley Nucleonics Corporation (BNC) provides information on its products and associated hazards, but it assumes no responsibility for the after-sale operation and safety practices.

ALL PERSONNEL WHO WORK WITH OR ARE EXPOSED TO THIS EQUIPMENT MUST TAKE PRECAUTIONS TO PROTECT THEMSELVES AGAINST POSSIBLE SERIOUS AND/OR FATAL BODILY INJURY. DO NOT PERFORM INTERNAL REPAIR OR ADJUSTMENTS UNLESS ANOTHER PERSON CAPABLE OF RENDERING FIRST AID AND RESUSCITATION IS PRESENT.

## **1.0 GENERAL DESCRIPTION**

The BNC PVX-4150 pulse generator is a high voltage solid state pulser designed to drive capacitive loads such as grids, deflection, reflection and acceleration plates.

The PVX-4150 will generate an output voltage swing of 1500 volts, and output current of 16 amperes peak and .05 amperes continuous. It produces very flat voltage pulses to DC into a capacitive load.

The PVX-4150 Pulser can generate single-ended output pulses from ground to +1500V or from ground to -1500V, and can also generate pulses originating from a voltage offset from ground. This offset can be from -1500V to +1500V, with a maximum power supply voltage differential ( $V_{high} - V_{low}$ )  $\leq 1500V$ .

## 2.0 SPECIFICATIONS

All specifications are measured into a 50pF load connected with 6 feet (~1.8M) of RG-62 (93Ω) coaxial cable

<b>INPUT DC VOLTAGE +V IN (<math>V_{high}</math>)</b>	
Source	External
Absolute Maximum Value	+1500 volts
Relative Maximum Value	+1500 volts above -V IN level
Absolute Minimum Value	-1500 volts
Relative Minimum Value	0 volts above -V IN level
Input Connector	Type SHV, Rear Panel (+V IN)
<b>INPUT DC VOLTAGE -V IN (<math>V_{low}</math>)</b>	
Source	External
Absolute Maximum Value	+1500 volts
Absolute Minimum Value	-1500 volts
Input Connector	Type SHV, Rear Panel (-V IN)
<b>OUTPUT PULSE VOLTAGE</b>	
Maximum Value	$\pm 1500$ volts (-V IN - +V IN)
Minimum Value	0 volts
Means of Adjustment	Controlled By Power Supply Input Voltages
Output Connector	Type SHV, Rear Panel (OUTPUT)
<b>GATE</b>	
Gate Source	External
Gate Input	+5V $\pm 1V$ into 50Ω
Gate Rise Time	<20ns
Gate Input Connector	Type BNC, Front Panel
<b>VOLTAGE MONITOR</b>	
Voltage Monitor	1000:1 into 1 MegΩ, 20 MHz Bandwidth Limit
Voltage Monitor Connector	Type BNC, Front Panel
<b>CURRENT MONITOR</b>	
Current Monitor Type	10A/V into 50Ω, 20 MHz Bandwidth Limit
Current Monitor Connector	Type BNC, Front Panel

<b>OUTPUT PULSE ELECTRICAL CHARACTERISTICS</b>	
Pulse Rise Time	<25ns 1500V (10%-90%, 50pF load)
Pulse Fall Time	<25ns (10%-90%)
Pulse Width	<60ns to DC, controlled by input gate
Pulse Recurrence Frequency	Single Shot to 240KHz, controlled by input gate <sup>(1)</sup>
Droop	<1% into a capacitive load
Maximum Duty Cycle	Continuous
Maximum Power Dissipation Into A Capacitive Load (CV <sup>2</sup> F)	150 Watts, Derated at 2W/°C over 25°C ambient <sup>(1)</sup>
<b>GENERAL</b>	
Support Power	90VAC to 240VAC, 50/60Hz
Dimensions (Excluding Connectors)	19" W x 5.2" H x 13" D (48.25cm W x 13.2cm H x 33cm D)
Weight (Approximate)	18 lbs. (8.2 Kilograms)

These specifications are measured driving a 50pF load connected with 6 feet of RG-62 cable, at 1500V output. However the PVX-4150 can drive loads of a few picofarads to several hundred picofarads of capacitance, limited by its maximum power dissipation capability<sup>(1)</sup>. At lower load capacitances and/or voltages less then 1500V, the PVX-4150 can operate at continuous pulse recurrence frequencies above 240KHz. The PVX-4150 can also drive resistive or inductive loads, within limitations. Contact BNC for additional information and applications assistance.

<sup>(1)</sup> The power dissipated in the PVX-4150 when driving a capacitive load is defined by the formula  $CV^2F$ , where C is the total load capacitance, including the capacitance of the load, interconnect cable, and the internal capacitance of the PVX-4150, V is the pulse voltage, and F is the pulse repetition frequency (or the total pulses per second). (For these calculations, the internal capacitance of the PVX-4150 is 200pF, and RG-62 cable is 13pf/foot.) Given the maximum dissipation of 150W, the maximum load capacitance, frequency and/or voltage at which the PVX-4150 can operate can be approximated using this formula. This formula also approximates the high voltage power supply requirements needed to drive a given load at a specific voltage and frequency. This formula is not applicable when driving resistive or inductive loads.

### **3.0 SAFETY**

The high voltage of this device dictates the use of caution when operating or servicing this equipment. The following is a summary of general safety precautions that must be observed during all phases of operation and repair of the PVX-4150.

#### **3.1 Operating Safety Summary**

The safety information contained in this summary is for both operating and servicing personnel. Specific warnings may be found throughout this manual, but may not appear in this summary.

##### **3.1.1 Power Source**

The PVX-4150 is designed to operate from a power source that will not apply more than 240 volts between the supply conductors or between either supply conductor and ground.

A protective grounding connection by way of the grounding conductor in the AC power cord is essential.

### 3.1.2 Grounding

The PVX-4150 is grounded through the grounding conductor of the AC power cord. **To avoid electrical shock, plug the PVX-4150 into a properly wired receptacle before making connection to any input or output connectors.** Use only a power cord that is in good condition.

### 3.1.3 Cover Removal

To avoid personal injury, do not remove the covers. **Do not operate the PVX-4150 while the covers are removed.** The covers do not contain a safety interlock!

### 3.1.4 General Operating Precautions

Do not remove the input or output cables while the pulser is in operation. Never short-circuit the output of the unit. Failure to observe these precautions can result in potential electric shock to personnel, arcing, and damage to the connectors and system.

The top cover of the PVX-4150 is not safety interlocked. Extreme caution should be exercised when removing the cover.

Any pulsed power system is capable of random triggering via transients. Therefore when the PVX-4150 is turned on, or dangerous voltage is present in the chassis, assume it is possible to get a pulse on the output connector.

## 3.2 Servicing Safety Summary

The PVX-4150 contains dangerous voltages and stored energy. BNC strongly recommends that all repairs and adjustments be performed by factory qualified personnel. BNC will not be responsible for personal injury or damage to the driver that occurs during repair by any party other than the factory.

### 3.2.1 Servicing Procedure

Do not perform internal repair or adjustments unless another person capable of rendering first aid and resuscitation is present.

### 3.2.2 Internal Energy Storage

The PVX-4150 contains capacitors that are used as energy storage elements. When charged, these capacitors contain approximately 0.5 joules of stored energy. This is sufficient energy to cause serious injury. **Assure that the AC**



**power cord is disconnected from the driver, and that the capacitor bank is fully discharged and a shorting strap installed before any repairs or adjustments are attempted.** Verify with a voltmeter that all circuits are de-energized before servicing. The voltmeter used to make these measurements must be certified for use at 3000VDC and 220VAC or greater. Dangerous voltages, floating ground planes and energy storage exist at several locations in the PVX-4150. Touching connections and/or components could result in serious injury.

## **4.0 OPERATING CONSIDERATIONS**

### **4.1 Output Cabling**

The PVX-4150 is designed to drive capacitive loads with fast rise times. Since the current out of the PVX-4150 is limited, the lower the capacitance, the faster the risetime. Given fixed load characteristics, only the interconnecting cable type and length will vary the output capacitance.

The unit is supplied with a 6 foot length of RG-62 coaxial cable which has a capacitance of 13.5pF per foot. The unit is series terminated in the characteristic impedance of this cable, which is 93Ω. BNC recommends that the shortest length of cable possible be used to ensure the fastest possible rise times and best pulse fidelity.

### **4.2 Load Simulation**

This unit was tested with a 50pF capacitive load connected to the output with 6 feet of RG-62 coaxial cable.

### **4.3 Trigger Input**

An input trigger of +5V ±1V into 50Ω with a risetime of <20ns is required to gate on the PVX-4150. Departure from these values can result in a loss of performance. These trigger requirements are met by any high quality low voltage pulse generator. The trigger should be set to +5V ±1V into 50Ω before the trigger cable is attached to the PVX-4150 trigger input. The input trigger amplitude should be set using a 50Ω load (e.g. a 50Ω scope input) before connecting it to the PVX-4150. If the trigger input is greater than +5V into 50Ω, pulse stretching can occur.

### **4.4 Pulse Voltages +V IN and -V IN**

The PVX-4150 Pulser is rated at a maximum pulse output voltage of ±1500VDC. Proper precautions should be taken by the user to ensure that the maximum voltage is not exceeded.

### **4.5 Output Pulse Considerations**

The PVX-4150 Pulser can generate single-ended output pulses from ground to +1500V or from ground to -1500V, and can also generate pulses originating from a voltage offset from ground. This offset can be from -1500V to +1500V, but the maximum power supply voltage differential ( $V_{high} - V_{low}$ ) should never exceed 1500V. The  $V_{high}$  supply should always be equal to or greater than the  $V_{low}$  supply, but never greater than 1500V above the  $V_{low}$

supply. Therefore the  $V_{low}$  supply may be set to any voltage between -1500V and +1500V, and the  $V_{high}$  supply may be set to any voltage between -1500V and +1500V, but the voltage difference between  $V_{low}$  and  $V_{high}$  should never exceed +1500V. If the unit is operated with a single power supply (i.e. single-ended), the unused power supply input should be grounded.

When the input gate is high, the  $V_{high}$  supply is connected to the output. When the input gate is low, the  $V_{low}$  supply is connected to the output. Therefore the PVX-4150 can be used to generate a negative-going pulse by logically inverting the input gate, so that the input gate is high until the unit is pulsed. When the input gate goes low, the  $V_{low}$  supply is connected to the output, thereby generating a negative going pulse (see the example in the figure below).

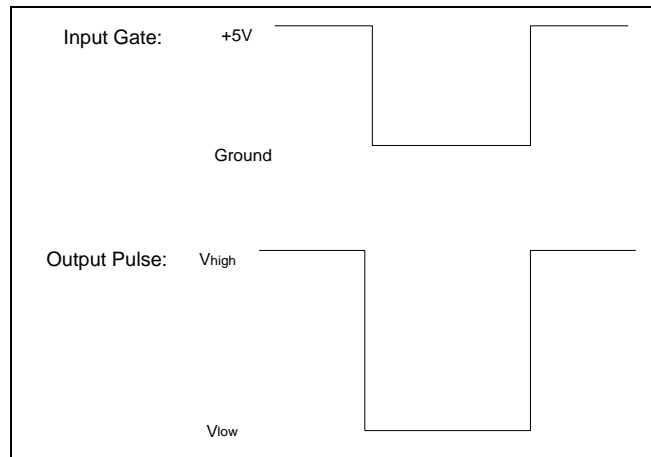

Generating a Negative Pulse With The PVX-4150

## 4.6 Controls and Indicators

### 4.6.1 Power Switch and LED

The switch labeled "POWER" controls all AC power in the chassis. The LED also labeled "POWER" above the switch illuminates when AC power is turned on.

### 4.6.2 Enable Switch and LED

The enable switch enables and disables the pulse output. When the switch is on, the output is enabled, and the "OUTPUT ENABLED" LED above the switch is illuminated.

If the enable LED is not illuminated, the PVX-4150 will not generate an output pulse. The external interlock circuit (on the rear panel DSUB

connector) must be satisfied before the PVX-4150 can be enabled. If the Enable LED does not illuminate when the enable switch is pressed, confirm that the external interlock circuit is satisfied.

#### 4.6.3 Gate Connector

The BNC connector labeled "GATE" is the input to gate the pulser. The input should be +5V into 50Ω, with a rise time less than 20ns. The output pulse width and frequency are controlled by the input gate's width and frequency.

#### 4.6.4 Gated LED

The LED labeled "GATED" illuminates when a gate signal of the appropriate amplitude and width to gate the pulser is received. If the "GATED" LED is not illuminated, the PVX-4150 will not generate an output pulse.

#### 4.6.5 Over Current LED

The LED labeled "OVER CURRENT" illuminates if the output pulse current exceeds 15A. If this LED illuminates, the pulse output will be inhibited for 6-7 milliseconds. If the LED illuminates continuously, the cause of the over current fault should be corrected before attempting to operate the pulser.

#### 4.6.6 Control Error LED

The LED labeled "CONTROL ERROR" illuminates if the input gate frequency exceeds ~250KHz. If this LED illuminates, the pulse output will be inhibited. If the LED illuminates, reduce the frequency of the input gate before attempting to operate the pulser.

#### 4.6.7 Current Monitor

The BNC connector labeled "I MON" provides a 10A/V monitor of the output current. This monitor should be terminated into 50Ω, such as the 50 Ω input of an oscilloscope.

#### 4.6.8 Voltage Monitor

The BNC connector labeled "V MON" provides a 1V/1000V monitor of the output pulse. This monitor should be terminated into 1 MegΩ, such as the 1 MegΩ input of an oscilloscope. Please note that due to the 20MHz Bandwidth limit on the V-MON, the rise and fall times will not be accurate.

#### 4.7 Remote Control

The PVX-4150 has the capability to be operated through remote controls. The following table provides the pinout of the 15 pin DSUB connector on the rear panel.

<b>PIN</b>	<b>FUNCTION</b>	<b>DESCRIPTION</b>
1	GND	Ground
2	GND	Ground
3	GND	Ground
4	GND	Ground
5	GND	Ground
6	Enable Status	Output: Active low, open drain, 24 mA maximum ON, 24 V DC maximum OFF
7	Control Error Status	Output: Active low, open drain, 24 mA maximum ON, 24 V DC maximum OFF (not used)
8	Power Status	Output: Active low, open drain, 24 mA maximum ON, 24 V DC maximum OFF
9	Enable	Input: Low-to-high transition to enable, disable, reset
10	Invert	Input: Pull low to invert the Gate input
11	Remote	Input: Pull low for remote operation
12	Interlock	Input: Pull low to satisfy the interlock
13	Auto Reset	Input: Pull low to enable auto reset
14	Over Current Status	Output: Active low, open drain, 24 mA maximum ON, 24 V DC maximum OFF
15	Gated Status	Output: Active low, open drain, 24 mA maximum ON, 24 V DC maximum OFF

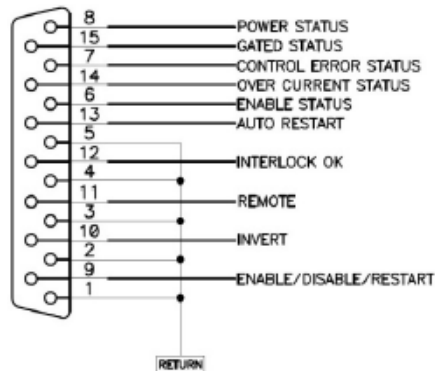

The control pins on the remote connector are internally pulled high. For remote operation, the REMOTE pin should be pulled low. This disables the Front Panel ENABLE switch to prevent local operation. The remote ENABLE, INTERLOCK, INVERT, and AUTO RESET inputs are always active, regardless of the state of this REMOTE signal. If the ENABLE signal is momentarily pulled low, the unit will be enabled, or a fault will be cleared, on the rising edge of that signal. If the INVERT pin is pulled low, the gate pulses going in to the unit will become inverted internally. Therefore, the output pulse will be inverted from that of the input gate.

**The INTERLOCK pin must be pulled low or jumpered to pin 4 in order to satisfy the PVX-4150's interlock circuit. If the INTERLOCK pin is not pulled low or jumpered to pin 4, the user will not be able to enable the output.** If the user is using the INTERLOCK pin, it should be pulled low to satisfy the interlock. Otherwise, it should be jumpered to pin 4.

The AUTORESET function allows the user to choose how to clear the faults. If the AUTORESET pin is pulled low, the unit will reset itself after 6msec when a fault occurs such as an overcurrent or interlock fault. If the AUTORESET is not pulled low, the user will have to reset faults manually. To reset a fault, the ENABLE pin should be pulled low two times: Once to reset the fault, and the second time to enable the output. If the user does not want to operate in the remote mode, pins 4 and 12 and pins 5 and 13 should be jumpered together. This satisfies the interlock and enables the autoreset function.

The PVX-4150 is shipped with a mating DSUB connector installed, and with pins 4 and 12 and pins 5 and 13 jumpered. Therefore as shipped, remote operation is disabled. **This connector must be installed in order to satisfy the interlock circuit. If it is not installed, the unit cannot be enabled.**

## 5.0 PREPARATION FOR USE

### 5.1 General

After unpacking, initial inspection and preliminary electrical check procedures should be performed to assure that the unit is in good working order. If it is determined that the unit is damaged, the carrier should be notified immediately. Repair problems should be directed to the service department. Telephone: (415) 453-9955.

### 5.2 Initial Inspection

1. Inspect unit for exterior mechanical damage.
2. Inspect power input cord and input power module for obvious signs of damage.

### 5.3 Electrical Installation

Standard units are shipped ready for use with a nominal 100 to 240 VAC input.

#### 5.3.1 Input Power Cord

The input power cord terminates externally in a three-prong polarized plug. The unit chassis is wired to the plug through the line cord, and therefore, the insertion of the plug into a compatible receptacle, hooked up to a grounded input, will automatically ground the unit. The unit should not be operated without a grounded AC input!

### 5.4 Electrical Check

Before proceeding, please review the precautions in Section 3.

#### 5.4.1 Power-Up

The unit should be powered up using the following procedures:

1. Install the mating rear panel DSUB connector supplied with the unit. This connector has pins 4 and 12 and pins 5 and 13 jumpered. Therefore as shipped, remote operation is disabled. **This connector must be installed in order to satisfy the interlock circuit. If it is not installed, the unit cannot be enabled.** In order to operate the PVX-4150 remotely or to use an external interlock, wire the DSUB connector accordingly (see the "Remote Control" section above).

2. Before connecting the pulse generator to the PVX-4150, set up the pulse generator output to deliver a +5V pulse ( $\pm 1V$ ) into  $50\Omega$ , with a rep rate of approximately 500Hz, and a pulse width of  $1\mu s$ .
3. Connect the positive output power supply to the rear panel SHV connector labeled +V IN. Connect the negative output power supply to the rear panel SHV connector labeled -V IN. For +1500V single-ended output, -V IN must be connected to ground. The power supply input should be grounded if no power supply is connected. Ensure that both power supplies are turned off.
3. Plug the power cord into the AC power input and turn on the front panel Power switch. The "POWER" indicator LED should turn on, indicating that the PVX-4150 is operational. If this does not occur, unplug the unit from the AC power, and refer to the Troubleshooting Section of this manual.
4. Connect the pulse generator to the front panel BNC connector of the PVX-4150 labeled "GATE".
5. The PVX-4150 is powered up in a faulted condition. Once the Gate is connected, the fault should be cleared within 5 seconds.
6. Enable the pulses by pressing the "ENABLE" button. The green LED labeled "OUTPUT ENABLED" should light. Note that if the above mentioned fault is not clear, the output will not be enabled until the 5 second time limit has expired and the "ENABLE" button is pressed again.
7. Connect an appropriate load to the rear panel SHV output connector.
8. It is possible to monitor the output voltage in two ways. One way is by connecting an appropriate high voltage probe to the output load, utilizing an appropriate attenuator if necessary. The second and easier way is to attach a 50 Ohm coax to the V-MON connector on the front panel. Please note that due to the 20MHz Bandwidth limit on the V-MON, the rise and fall times will not be accurate.
9. Slowly turn up the high voltage power supplies. The PVX-4150 should produce an output pulse, with a pulse width and pulse recurrence frequency following that of the incoming trigger.
10. If there is no output from the PVX-4150, or the output is severely distorted, turn OFF the high voltage power supplies. Leave the PVX-4150 connected to the AC input without pulse voltage and with all connectors in place for approximately five minutes to bleed off the stored energy, then disconnect the AC power to the unit and refer to the Troubleshooting Section of this manual.



## **6.0 OPERATING INSTRUCTIONS**

This section provides basic operating instructions for the PVX-4150. Additional application information may be found in Section 7.0.

### **WARNING**

1. To avoid personal injury, do not remove the covers. Do not operate the PVX-4150 while the covers are removed. The covers do not contain safety interlocks!
2. Do not remove the input or output cables while the driver is in operation. Never short-circuit the pulse voltage output of the pulser. Failure to observe these precautions can result in potential electric shock to personnel, arcing, and damage to the connectors and system.
3. The covers of the PVX-4150 are not safety interlocked. Extreme caution should be exercised when removing the covers.
4. Pulsed power systems are capable of random triggering via transients and therefore when the PVX-4150 is turned on, or voltage is present in the chassis, assume it is possible to get a pulse on the output connector.

### **6.1 Power-Up Procedures**

The unit should be powered up using the procedures detailed in Section 5.3.1. When this is accomplished, the driver can be adjusted for the particular application through the following procedure:

1. Monitor the output of the PVX-4150 on an oscilloscope utilizing a high voltage probe connected to the output load, or with a coax attached to the V-MON in the front panel. Set the output amplitude of the PVX-4150 to the desired level by adjusting the output voltage of the high voltage power supplies.
4. Set the output pulse width and pulse recurrence frequency by varying the controls of the input pulse generator. The output pulse width should be set by monitoring the output of the PVX-4150. The output pulse voltage will follow the input trigger, but will not replicate in time the exact duration of the input trigger due to the system propagation delay.

### **6.2 Power-Down Procedures**

1. Set the controls of the high voltage power supplies to zero.
2. Turn off the high voltage power supplies.

3. Leave the PVX-4150 connected to the AC input without high voltage and with all connectors in place for approximately five minutes to bleed off the stored energy.
4. Disconnect the AC power to the unit.

## **7.0 TROUBLESHOOTING**

### **WARNING**

The PVX-4150 contains capacitors that are used as energy storage elements. When charged, these capacitors contain approximately 0.5 joules of stored energy. This is sufficient energy to cause serious injury. **Assure that the AC power cord is disconnected from the driver, and that the capacitor bank is fully discharged and a shorting strap installed before any repairs or adjustments are attempted.** Verify with a voltmeter that all circuits are de-energized before servicing. The voltmeter used to make these measurements must be certified for use at 3000VDC and 220VAC or greater. Dangerous voltages, floating ground planes and energy storage exist at several locations in the PVX-4150. Touching connections or components could result in serious injury.

### **7.1 Troubleshooting Procedures**

Before attempting to service or troubleshoot the PVX-4150, review the servicing safety summary in Section 3.0.

The power MOSFETs utilized in the PVX-4150 are mounted on the printed circuit board. In the unlikely event that the MOSFETs need be replaced, it is highly recommended that the unit be returned to the factory for servicing.

The table below summarizes potential problems and their solutions. If these recommendations do not resolve the problem, BNC customer service can be contacted for further assistance.

<b>SYMPTOM</b>	<b>SOLUTIONS</b>
"POWER" LED Does Not Illuminate	<ul style="list-style-type: none"> <li>• AC power not plugged in.</li> </ul>
Cannot Enable Output	<ul style="list-style-type: none"> <li>• Fuse(s) are blown. See fuse replacement instructions in Section 7.1.1</li> <li>• External remote interlock circuit is not satisfied</li> </ul>
No Output Pulse	<ul style="list-style-type: none"> <li>• Output is not enabled</li> <li>• No input trigger</li> <li>• Input trigger voltage too low</li> <li>• Input trigger pulse width too short. Increase width.</li> <li>• Input trigger frequency too high. Reduce frequency.</li> <li>• No high voltage. Check power supplies</li> <li>• Output not connected correctly. Check all cables and connections.</li> <li>• Pulser is damaged. Contact BNC customer service.</li> </ul>

### 7.1.1 Fuses

To avoid fire hazard or damage to the driver, use only the fuse types listed below. Fuse replacement should be performed by qualified personnel only. **Assure that the AC power cord is disconnected from the driver, and that the capacitor bank is fully discharged and a shorting strap installed before fuse replacement is attempted. Verify with a voltmeter that all circuits are de-energized before servicing.** The voltmeter used to make these measurements must be certified for use at 3000VDC and 220VAC or greater.

#### FUSE LOCATION

AC Entry Module

#### FUSE VALUE

3A, 250VAC Fast Blow

### 7.2 Factory Service

If the procedures above fail to resolve an operational problem, please contact the factory for further assistance:

Berkeley Nucleonics Corp. San Rafael USA  
Call: (415) 453-9955  
Email: [info@berkeleynucleonics.com](mailto:info@berkeleynucleonics.com)

## **8.0 SYSTEM FAILURE MODES**

The PVX-4150 is capable of generating large amplitude current pulses with very fast rise and fall times. There is limited over-current or over-voltage protection circuitry, and it is the user's responsibility to assure that the interconnect cables and load do not create transients, over-current or over-voltage conditions that could damage the PVX-4150. FAILURE TO DO SO VOIDS THE WARRANTY.

### **8.1 Over-Current Failure**

When the output is shorted, the PVX-4150 can deliver in excess of 16A of current (depending on cabling, pulse power supply setting, etc.). A current pulse of this magnitude is in excess of the driver's specifications. If allowed to operate into a short for an extended period of time, damage to the unit, load and/or associated cabling may result.

## **9.0 WARRANTY**

There are no warranties, express or implied, including any implied warranty of fitness for a particular purpose nor any IMPLIED WARRANTY OF MERCHANTABILITY made by Berkeley Nucleonics Corp. (BNC) except as follows:

BNC warrants equipment manufactured by it to be free from defects in materials and/or workmanship under conditions of normal use for a period of ninety (90) days from the date of shipment to the purchaser. BNC will repair or replace, at BNC's option, any product manufactured by it which is shown to be defective or fails to perform within specifications within ninety (90) days from the date of shipment to the purchaser. OEM, modified and custom items of equipment are similarly warranted, for a period of ninety (90) days from date of shipment to the purchaser.

Equipment claimed to be defective must be returned, transportation prepaid, to BNC's factory in Colorado within the warranty period. Returns must be preauthorized by contact with BNC's customer service department. Written documentation of such preauthorization shall be included with the returned item.

At BNC's discretion, BNC may elect to repair or replace the equipment claimed to be defective or refund the original purchase price, plus taxes and transportation charges incurred by the purchaser.

This Warranty shall not apply to any product that has been:

1. Repaired, worked on, or altered by persons unauthorized by BNC;
2. Subjected to misuse, neglect, or damage by others; or
3. Connected, installed, adjusted, or used in a manner not authorized in the instructions or specifications furnished by BNC.

This warranty is the purchaser's sole remedy for claimed defects in the equipment sold or manufactured by BNC. BNC's liability to the purchaser is limited to the repair or replacement of the claimed defective equipment or, at BNC's option, refund of the purchase price, taxes and transportation charges incurred by the purchaser. BNC will not be responsible for or liable to the purchaser for consequential losses or damages asserted to be attributable to a claimed defect in the equipment provided.

Changes made by BNC in the design or manufacture of similar equipment which are effected subsequent to the date of shipment of the warranted equipment to the purchaser are reflective of BNC's program of constant product development and improvement and shall not be construed as an acknowledgment of deficiency in the product shipped to purchaser. BNC will be under no obligation to make any changes to product previously shipped.

## APPENDIX

### Typical Output Waveforms

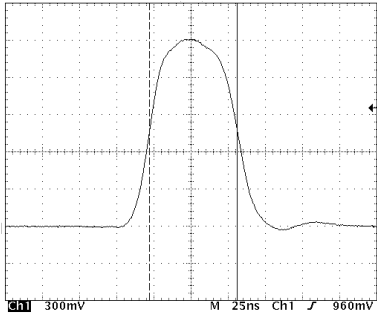

**<60ns Minimum Pulse Width, 1500V Output**  
(25ns/Div horizontal scale, 300V/Div vertical scale)

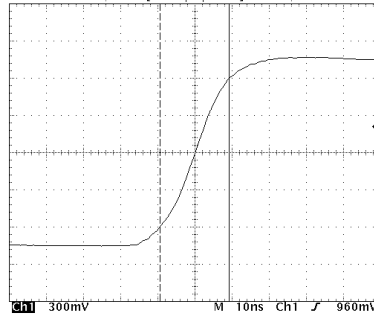

**18ns Rise & Fall Times, 1500V Output**  
(10ns/Div horizontal scale, 300V/Div vertical scale)

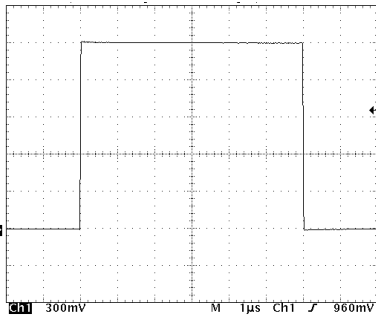

**Typical Output Waveform, 1500V**  
(1µs/Div horizontal scale, 300V/Div vertical scale)

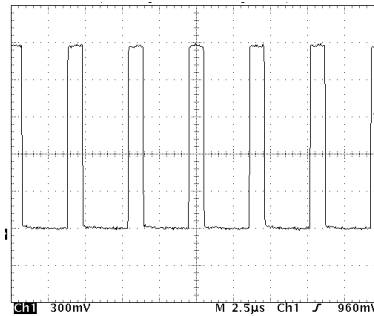

**244KHz Frequency, 1500V Output**  
(2.5µs/Div horizontal scale, 300V/Div vertical scale)